

# weston

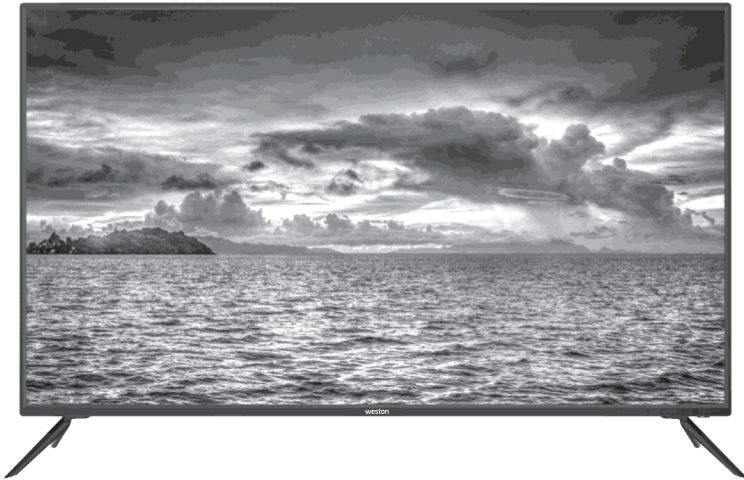

## USER MANUAL

PLEASE READ THIS USER GUIDE CAREFULLY BEFORE USING YOUR DEVICE AND KEEP IT FOR FUTURE REFERENCE!

CE

# CONTENTS

1.Safety Instructions.....	3
2.Remote Control Functions.....	9
3.Implementation of Tabletop Display Stand.....	13
4.LED Display Setup.....	14
5.Front and Back Panel Diagrams.....	15
6.32WS2000 / 24WS1000 / 32WS1000 / 32WS1001.....	23
6.1.Input Source Selection.....	23
6.2.TV Functions.....	23
6.2.1.Menu.....	23
6.2.1.1.Channel.....	23
6.2.1.2.Picture.....	25
6.2.1.3.Sound.....	25
6.2.1.4.Time.....	25
6.2.1.5.Lock.....	26
6.2.1.6.Setup.....	26
6.2.1.7.Use with Terrestrial Antenna.....	26
6.2.1.8.Media Player Functions.....	27
6.3.Technical Specifications.....	27

## ANDROID TV

7.32WS2100 / 40WS2102 / 42WS2102 / 43WS2103 / 50WS2104 55WS2104 / 65WS2104 / 32WS1100 / 40WS1102 / 43WS1102.....	28
7.1.Setup.....	28
7.2.TV Functions.....	28
7.2.1.Menu.....	28
7.2.2.Input Function Selection.....	29
7.2.3.Picture.....	29
7.2.4.Sound.....	30
7.2.5.Channel Menu.....	31

- 7.2.6.Lock.....32
- 7.2.7.General Settings.....32
- 7.3.Homepage.....34
  - 7.3.1.Media Player Features.....35
  - 7.3.2.Settings.....36
- 7.4.Technical Specifications.....37
- 8.50WS1104 / 55WS1104 / 65WS1104.....38
- 8.1.Setup.....38
- 8.2.TV Functions.....38
  - 8.2.1.Menu.....38
    - 8.2.1.1.Selection of Input Sources.....38
    - 8.2.1.2.Picture Menu.....40
    - 8.2.1.3.Sound Menu.....41
    - 8.2.1.4.Channel Menu.....41
  - 8.2.3.Accessibility Menu.....46
    - 8.2.3.1.Advanced Menu.....47
    - 8.2.3.2.Lock Menu.....48
    - 8.2.3.3.General Menu.....49
    - 8.2.3.4.System Menu.....50
    - 8.2.3.5.Network Menu.....51
    - 8.2.3.6.Application Menu.....52
  - 8.2.4.Home page.....53
    - 8.2.4.1.Media Player Features.....54
- 8.3.Technical Specifications.....55
- 9.Troubleshooting.....55
- 10.Information.....56

# SAFETY INSTRUCTIONS



This device contains high voltage electricity. To avoid the risk of electric shock, please do not remove the device cover. If you encounter a problem, please contact one of our authorized service centers.

Any change or incorrect setting of the LED Display can result in electric shock. Do not open the device for maintenance or repair; do not modify the device's equipment; or allow unqualified people to intervene with it. If you encounter any problems, please contact one of our authorized service centers

## Precautions Against Permanent Screen Damage

Images remaining still on the screen for more than 2 hours will cause permanent screen damage. Therefore, when using the device, keep the pause times as short as possible and switch off the device if there is a possibility of a prolonged pause. You can also adjust the "Brightness" and "Contrast" settings to lower levels in the event of a pause.

## WARNING!



The "exclamation mark in an equilateral triangle" reminds the user of important operating and maintenance (servicing) instructions that must be followed when using the appliance in question.



The "lightning bolt with arrow" or "broken arrow" sign in an equilateral triangle warns the user of the presence of an uninsulated "dangerous voltage" level in the vicinity of the appliance which, if contacted, could pose a hazard to humans.

1. Please read this user guide carefully before using the LED Display and keep it for future reference. If the device is given to another person, give the operating instructions along with the device.
2. Unpack the device and check that there is no damage to the device, its accessories, or the cable. In case of any damage, breakage, or cracks on the device or the cable, or if the accessories are damaged or missing, do not use the device and contact your nearest authorized service center.
3. Plastic bags are extremely dangerous for children and babies. Never allow children and babies to play with the nylon plastic bags of the device or its accessories. Do not leave nylon plastic bags near children and babies.
4. To avoid the risk of fire and electric shock, do not use the appliance in excessively humid and damp conditions or near places with water such as bathrooms, bathtubs, sinks or swimming pools.
5. Do not leave the device in precipitation (exposed to rain, snow, or wind), where water may be splashed or spilled, or in a position where the device may fall into water. Make sure that no water or other liquid gets on the device. Vases, jugs, and other containers filled with water or other liquids should not be placed near the device. Do not use the device in environments where it may be exposed to water vapor or moisture, as well as around humidifiers.
6. Keep the LED display away from all heat sources, such as stoves, radiators, electric stoves, etc., and devices that generate magnetic fields. Do not leave the device or its remote control in the vicinity of flames, fire or liquid sources, or objects that may pose a hazard to avoid the risk of fire or damage to the device.

Keep the device, remote control, remote control batteries, and other accessories
7. away from direct sunlight and heat sources. Before plugging the device into an electrical outlet, make other connections and make sure that all connections are
8. made correctly.

Before making any connections, turn off the device and disconnect the power cord. Before installation, maintenance, cleaning or transportation, unplug the device from the power outlet.
9. Before connecting the device's power plug, ensure that the electrical network is suitable for the values specified on the device (AC 100-240V-50/60HZ) and that the line is protected with a suitable fuse. Even if the power switch, if any, is turned off, the device must not be disconnected from the power supply unless the power plug is removed from the socket.
10. Insert the power plug into a socket located at the back of the device so that the cord is not stepped on and is easily accessible when needed.

11. Make sure that the power plug is fully inserted into the socket. Make sure that there is no water, moisture or dust in the inlet of the power plug and socket.
12. It is the responsibility of the consumer to ensure that the electrical network for the device is suitable and that it is installed by a qualified electrician. The manufacturer cannot be held responsible for any damage to the device caused by the use of the device in electrical networks that do not comply with local regulations.
13. Never use broken or deformed electrical sockets. Remove the power plug from the socket by holding the plug, do not pull by the cord. Do not leave the power cord of the device under or on objects such as carpets or rugs where it can be stepped on, and avoid crushing the power cord. If the power cable is damaged, do not use the device and contact an authorized service center.
14. Do not use an extension cord or socket group to operate more than one high-power electrical device in the same socket. Overloading the power outlet can cause fire and electric shock. If an extension cable is required, make sure it meets the device's specifications.
15. Do not overtighten, knot, connect, or coil the device's power cable to other connecting cables or the power cables of other devices.
16. Do not leave the power cord of the appliance on wet or hot surfaces, and keep it out of the reach of children.
17. Never open the back cover of the device and do not attempt to modify the equipment. The device contains non-isolated hazardous voltage, which could result in electric shock and other life-threatening hazards.
18. Only use original and manufacturer-authorized accessories with the device.
19. Make sure that no part of the device, particularly the screen, has been hit or broken. Impact to the device or the screen may cause malfunction of the device and serious injury.
20. Be careful not to scratch the screen. Hard or sharp objects can easily damage the screen. Also, do not apply excessive pressure to the screen with your hand or any other object.
21. Place the device on a hard, level surface that can support its weight; never place it on a slanted surface. Use only the stand, mounting bracket, or other accessories supplied with the device or recommended by the manufacturer to prevent possible tipping. Only mount the LED display on the wall or ceiling as recommended.
22. Unplug the device from the mains socket during thunderstorms, heavy rain, and when it will not be used for a long period of time.
23. Never cover the device. Do not cover the ventilation holes of the device with cloths, newspapers, etc. Allow at least 10 cm of ventilation space on the back, sides, and top of the device.

24. Do not use the device in potentially hazardous or poorly ventilated areas. Do not use the device in narrow and closed spaces such as shelves and display cases, without proper ventilation.
25. Do not place any objects on the device.
26. Do not allow any solid or liquid substances to enter through the ventilation holes on the device. Metal objects and liquids, in particular, pose a risk of short circuiting or electric shock, as well as device damage and fire. If solid or liquid substances get into the device, immediately disconnect the power plug from the socket and do not operate the device again until it has been checked by an authorized service center.
27. The device is intended for home use. Do not use the device outside. Use the device only for its intended purpose; do not use it for industrial or commercial purposes.
28. The manufacturer is not responsible for any malfunction or damage caused by improper or incorrect use.
29. The following are some general rules to follow when using any electrical device:
30. Never touch the device and the power cord with wet or damp hands.
31. Never leave the device out in the rain, near water, in extremely humid environments, or in direct sunlight.
32. Inspect the device and the power cable for damage on a regular basis.
33. Before cleaning the device, turn it off and remove the power plug from the socket. Clean the device periodically. Wipe the device down with a slightly damp soft cloth and then dry with a dry soft cloth. Do not spray cleaning agents on the device, immerse it in water or other liquids, or pour water or other liquids on it. Do not use abrasive materials to scrape the device's surface.
34. Do not pour or spray any liquid on the screen for cleaning purposes. Do not use excessive pressure on the screen during cleaning. Otherwise, it may cause scratches on the screen and image distortion.
35. Do not leave the device running and walk away from it for an extended period of time. When not in use, turn off the device and remove the power plug from the socket.
36. Do not allow small children to use or play with the device. Do not leave the device running in the presence of children, and walk away from them. Do not allow children to come into contact with the device while it is working.
37. Do not allow small children to play with the remote control or other accessories, and keep the remote control and other accessories out of the reach of children. Swallowing remote control batteries or small accessories can be life-threatening. In case of battery swallowing, contact a health care provider immediately.
38. Do not use the device near or in the presence of flammable, combustible, or explosive materials. Make sure there is no gasoline, thinner, alcohol, paint, or any

- other flammable or combustible material in the area where the device will be used.
39. Do not use the device in excessively dusty environments where hot particles or sparks may enter the device.
  40. When using the device with headphones, make sure that the volume is not too high. High levels of noise can result in temporary or permanent hearing loss.
  41. Watching a screen in darkness or low light can cause eye strain. It is recommended that the screen be watched at an appropriate light level.
  42. The USB terminal of the device must not be loaded with currents higher than 0.5 A (500 mA).
  43. When the device is watched from different angles, the color and brightness of the image may differ. This is normal and does not indicate a problem with the device.
  44. On the screen, small black and/or brightly colored dots up to 1 ppm in size may be present. These points do not indicate that the product is defective and do not affect its performance or reliability.
  45. Do not mix old and new batteries, as well as batteries from different brands, models, and types. Replace dead batteries with new ones of the same size and capacity.
  46. Dead batteries should be disposed of in accordance with local laws and regulations and should not be thrown away with other household waste.
  47. If the device is struck or damaged in any way, if foreign objects enter the device, or if odors or smoke emanate from the device, immediately disconnect the power plug from the mains and contact an authorized service center.
  48. This device is not intended for use by people with physical, sensory, or mental disabilities, inexperienced or uninformed people, or children who are not supervised by an adult.
  49. In the event of damage to the power cable, never use the device, do not attempt to replace the cable yourself, or allow unauthorized persons to intervene with the device. The power cable must be replaced with a suitable cable by an authorized service center.
  50. If the device is damaged or malfunctioning, immediately turn it off and remove power plug from the socket. Do not use damaged devices. Never open the device cover, attempt to repair the device yourself, or allow unauthorized persons to intervene with the device without contacting an authorized service center.
  51. Do not allow small children to play with the remote control and remote control batteries, and keep the remote control out of the reach of children. Swallowing remote control batteries or accessories can be life-threatening. In case of battery swallowing, contact a health care provider immediately.



## **Matters to be Considered During Transportation and Shipping:**

1. Transport the device in its original packaging and protective accessories.
2. During handling or transportation, do not allow the device to fall, be crushed, or be hit in any way. Do not use the device if it has been dropped or hit, and contact an authorized service center.

## **Precautions Against Permanent Screen Damage**





Images remaining still on the screen for more than 2 hours may cause permanent screen damage. Therefore, when using the device, keep the pause times as short as possible and switch off the device if there is a possibility of a prolonged pause. You can also adjust the "Brightness" and "Contrast" settings to lower levels in the event of a pause.

**Note:** All illustrations, diagrams and function descriptions in this manual are for reference only. The manufacturer reserves the right to make changes in product appearance, specifications and functions without prior notice. Please keep in mind that the software may alter the device's functionality.

# REMOTE CONTROL FUNCTIONS

**32WS2000 / 32WS2100 / 40WS2102 / 42WS2102 / 43WS2103  
50WS2104 / 55WS2104 / 65WS2104**

**WARNING:** Do not allow small children to play with the remote control and remote control batteries, and keep the remote control out of the reach of children. Swallowing remote control batteries or accessories can be life-threatening. In case of battery swallowing, contact a health care provider immediately.

1.  On/Off: turns the screen on while in standby state and turns it off in standby state when the screen is on.
2.  Mute: Mutes the sound completely, when pressed again unmutes the sound.
3. TV: When in broadcast mode, switches between antenna types (aerial, cable, and satellite). Switches to Satellite Mode while on the SmartTV screen.
4. SLEEP: Auto power off timer.
5. EPG: Displays the broadcast program and program description for the channel being watched. (For supported satellite broadcasts)
6. P. MODE: Changes the picture mode.
7. ASPECT: Changes the screen aspect ratio.
8. LANG: Changes the audio language of the channel being watched. (For supported satellite broadcasts)
9. S. MODE: Changes the audio mode.
10. VOL + / VOL- : Increase/decrease the volume.
11. SOURCE: Changes the Input Source.
12. HOME: Switches to the SmartTV home page.
13. P + / P-: Increases / decreases the channel number.
14.  REC: Records the current broadcast. (USB memory required.)
15.  Stops multimedia files. Press again and playback resumes.
16.  Ends the started recording. Closes the multimedia file being watched.
17. T. SHIFT: Initiates time shift (USB memory required.)

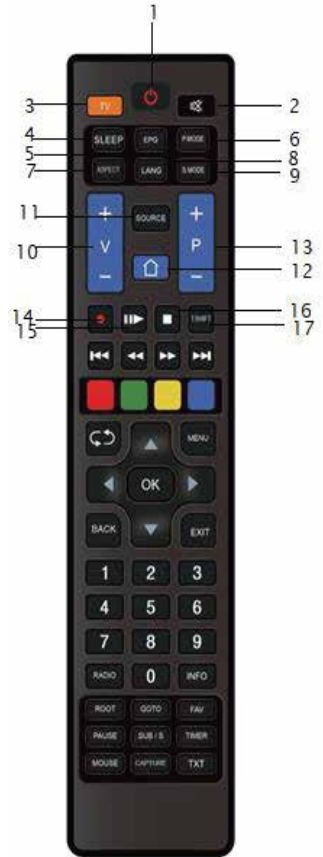



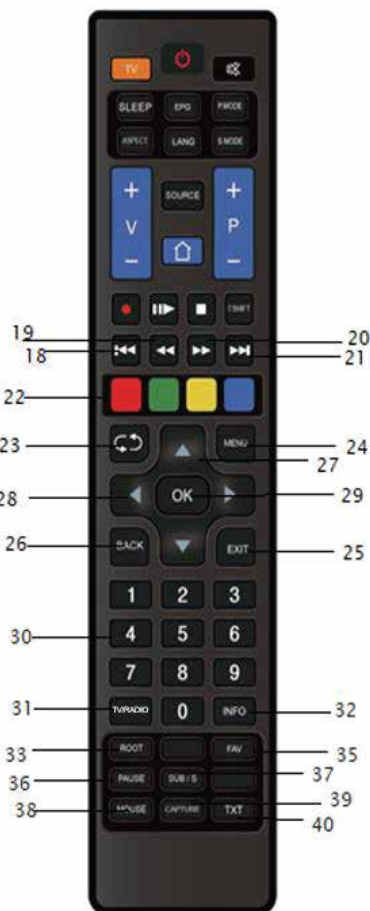

18. **⏮** : while playing a multimedia file, returns to the previous file.
19. **⏪** : Fast rewind while playing a multimedia file.
20. **⏩** : Fast forward during multimedia file playback.
21. **⏭** : Moves to the next file while the multimedia file is playing.
22. **RED/GREEN/YELLOW/BLUE**: Selects the NEWS/SPORT/WEATHER/ECONOMY categories on the Teletext screen.
23. **↺** : Returns to the previously opened channel.
24. **MENU**: Opens and closes the menu, returns to the upper menu.
25. **EXIT**: Closes the current menu.
26. **BACK**: Returns to the upper menu. Returns to the previous operation.
27. **▲▼** : Keys to select the section to be adjusted. Increases / decreases the channel number.
28. **◀▶** : the selected section can be set with these buttons.
29. **OK**: Used to save/confirm the selected or set menu options.
30. **0-9 Number Buttons**: Navigates to the channel whose number is entered. Allows entry of numeric values from the menu.
31. **RADIO**: Switches to Radio channels while watching satellite broadcasts. Pressing again returns to Satellite Channels.
32. **INFO**: Provides information about the current monitoring mode. Provides information about the currently playing multimedia file. Shows the registration information during registration.



NOTE: The functions of some keys may change depending on software development.

33. **ROOT**: Opens the media center.
34. **FAV**: Opens the favorite channel list.
35. **PAUSE**: Stops the multimedia file while it is playing.
36. **SUB/S**: Shows subtitle options for supporting broadcasts.
37. **MOUSE**: Activates the mouse while on the SmartTV home screen.
38. **CAPTURE**: Takes a screenshot of the image being viewed.
39. **TXT**: Displays the Teletext.

## 24WS1000 / 32WS1000 / 32WS1001 / 32WS1100 / 40WS1102 / 43WS1102 50WS1104 / 55WS1104 / 65WS1104 Remote Control Functions

1.  On/Off: turns the screen on while in standby state and turns it off in standby state when the screen is on.
2.  Mute: Completely mutes the sound, when pressed again turns the sound back on.
3. 0-9 Number Buttons: Navigates to the channel whose number is entered. Allows entry of numeric values from the menu.
4. P. MODE: Changes the picture mode.
5.  : Returns to the previously opened channel\*.
6. TV: When in broadcast mode, switches between antenna types (aerial, cable, and satellite). Switches to Satellite Mode while on the SmartTV screen.
7. EPG: Displays the broadcast program for the channel being watched.
8. SLEEP: Auto power off timer
9. VOL + / VOL- : Increase/decrease the volume.
10. TV-RADIO: When pressed switches to radio channels, when pressed again returns to the satellite channels.
11. ASPECT: Changes the aspect ratio of the displayed image in the TV function.
12. CH + / CH-: Increases / decreases the channel number.
13. FAV: Opens the favorite channel list.
14. HOME: Switches to the SmartTV home page.
15. REC: Records the current broadcast (USB memory required.)
16. MENU: Opens/closes the menu. Returns to the upper menu.
17. SOURCE: Changes the Input Source.
18. EXIT: Closes the current menu. Returns to the upper menu. Returns to the previous operation.
19. DISPLAY: Provides information about the current monitoring mode. Provides information about the currently playing multimedia file. Shows the registration information during registration.
20.  : Keys to select the section to be adjusted. Increases / decreases the channel number.
21.  : the selected section can be set with these buttons.

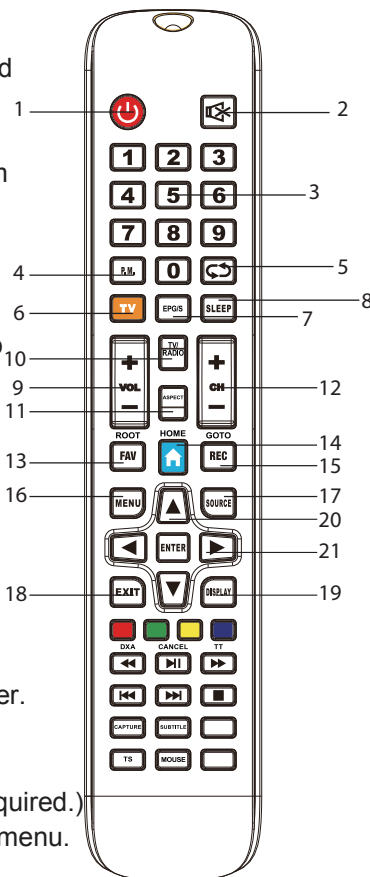

22. ENTER: Used to confirm or save the selected or set menu options.

23. RED/GREEN/YELLOW/BLUE: Selects news/sports/ weather/economy categories on the Teletext screen.

24. ◀◀: Fast rewind while playing a multimedia file.

25. ⏸: Stops multimedia files and resumes playback when pressed again.

26. TT / ▶▶: Displays teletext on the TV tab. Fast forward when playing multimedia files on the SmartTV screen.

27. ◀◀: Returns to the previous file while the multimedia file is playing.

28. ▶▶: Moves to the next file while the multimedia file is playing.

29. ■: Ends the started recording.

30. CAPTURE: Takes a screenshot of the image being viewed.

31. SUBTITLE: Shows subtitle options for supporting broadcasts.

32. T. SHIFT: Initiates time shift (USB memory required.)

33. MOUSE: When the button is pressed, the SmartTV screen shows a mouse.

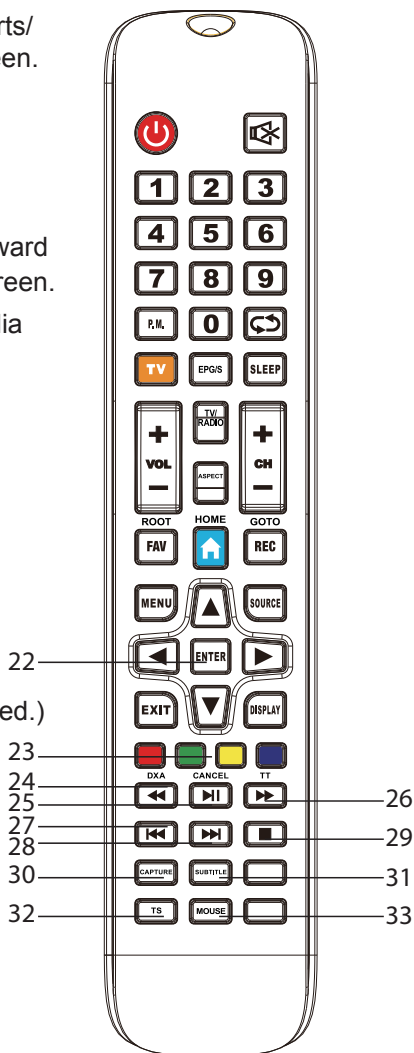

\*Not valid for models without built in satellite receiver.

**WARNING:** Keep the remote control device away from direct sunlight, heat sources, fire, and radiation emitting devices.

### Inserting the Batteries:

Open the battery compartment cover on the back of the remote control. Insert two AAA batteries, paying attention to the + and - poles, into the battery compartment. Do not use old and new batteries or different types of batteries at the same time. Replace the battery compartment cover and make sure that it is tightly closed.

# Implementation of Tabletop Display Stand

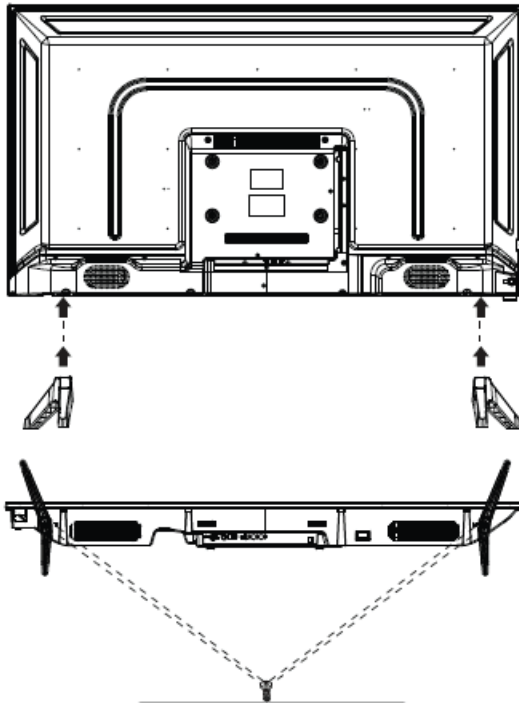

1. Take the LED display and its accessories out of the box.
2. Place the device on a table covered with a clean, soft cloth, with the screen on the bottom, to avoid screen damage.
3. Attach the feet to the device by pushing them in the direction indicated by the arrow in the figure above.

Attach the feet to the device using the screws, and secure the screws tightly.

## LED Display Setup

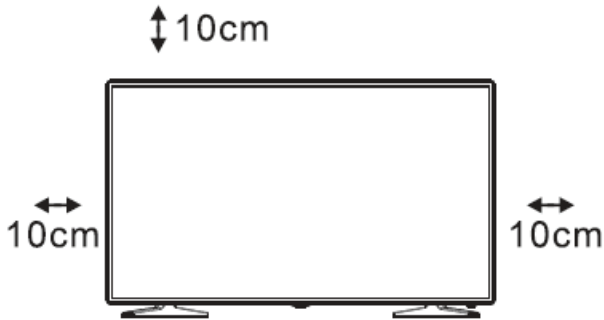

**LED Display Setup:** Place the LED display on a smooth surface that can support its weight. To avoid potential hazards, do not leave the LED display in extremely humid or hot environments or close to heat sources. Leave a gap of at least 10 cm in all directions and do not cover the ventilation holes on the display back panel, as shown in the figure.

### Connecting the Power Plug:

Insert the power plug into the socket. Before connecting the device's power plug to the mains socket, make sure that the mains supply corresponds to the values indicated on the technical label of the device (AC 100-240V ~ 50/60Hz).

### Operating the Led Display:

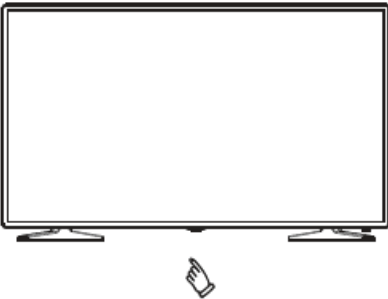

Turn on the LED display by pressing the On/Off button on the bottom of the device. The indicator light will glow green.

**NOTE:** Images and descriptions are for reference. There may be differences in product appearance and button locations.



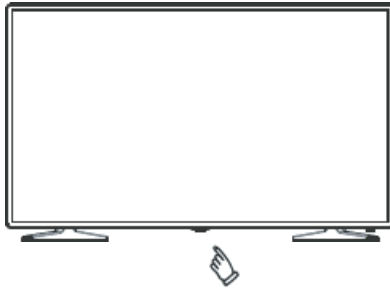



# FRONT PANEL DIAGRAMS



1	Smart button	Please read the explanation below.
2	LED	When the TV is in standby mode, it lights up red.
3	Remote Remote Control	Infrared receiver sensor for remote control

You can control the following functions from the device without a remote control. You can use the smart button on the device for this. Select the desired icon by pressing the button repeatedly for a short time. Press and hold the button to activate the function for the selected icon. The icons disappear automatically after 5 seconds. Touch the key at the bottom of the screen to display the control icons.

## Symbols and their functions

-  : Power-off symbol: Turns the device off.
-  : Menu symbol: Brings the menu to the screen.
-  : Input source selection symbol: Selects the input source.
-  : Channel up symbol: Switches to the next upper channel.
-  : Channel down symbol: Switches to the lower channel.
-  : Volume up symbol: Increases the volume.
-  : Volume down icon: Reduces the volume.



# BACK PANEL DIAGRAMS

## 32WS2000 LED TV

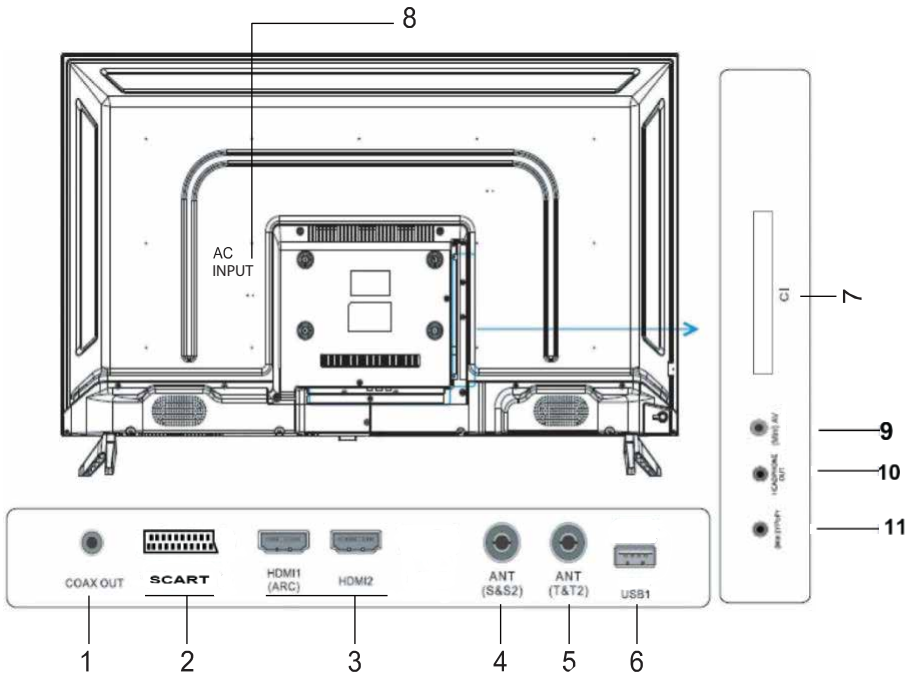

NO	INPUT/OUTPUT NAME
1	Coaxial Digital Audio Output
2	Scart
3	HDMI Inputs
4	Satellite Receiver Antenna Input (LNB)
5	Terrestrial Antenna Input
6	USB Port
7	CI Module Input
8	Power Supply Cable (110-220V AC 50/60 Hz)
9	Mini AV Video and Audio Input
10	Headphone Output
11	Mini YPbPr Input

# 24WS1000 / 32WS1000 / 32WS1001 LED TV

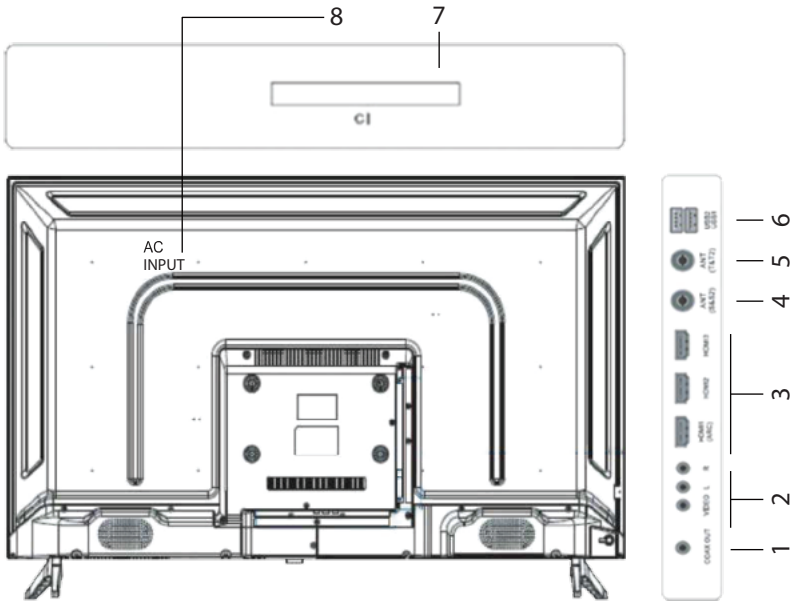

NO	INPUT/OUTPUT NAME
1	Coaxial Digital Audio Output
2	AV Video and Audio Input
3	HDMI Inputs
4	Satellite Receiver Antenna Input (LNB)
5	Terrestrial Antenna Input
6	USB Ports
7	CI Module Input
8	Power Supply Cable (110-220V AC 50/60 Hz)

# 32WS2100 / 40WS2102 / 42WS2102 SMART LED TV

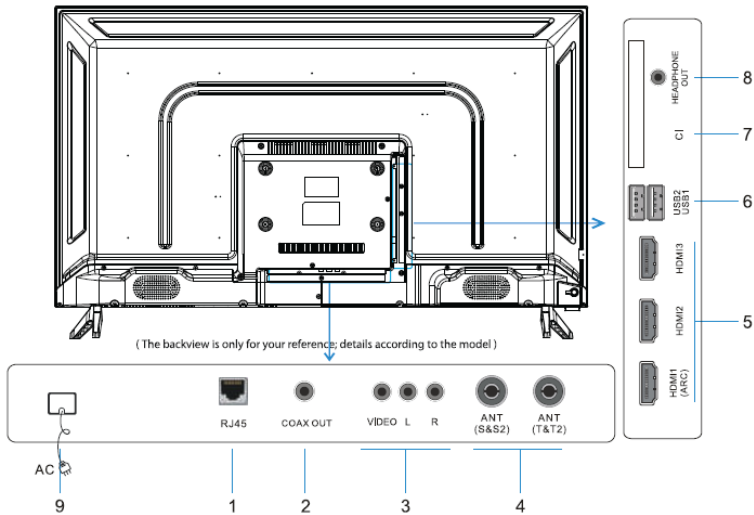

NO	INPUT/OUTPUT NAME	NO	INPUT/OUTPUT NAME
1	RJ45 Ethernet Connection	6	HDMI Inputs
2	Coaxial Digital Audio Output	7	USB Ports
3	AV Video and Audio Input	8	Common Interface (CI) Module
4	Satellite Receiver Antenna Input (LNB)	9	Headphone Output
5	Terrestrial Antenna Input	10	Power Supply Cable (110-220V AC 50/60 Hz)

# 43WS2103 SMART LED TV

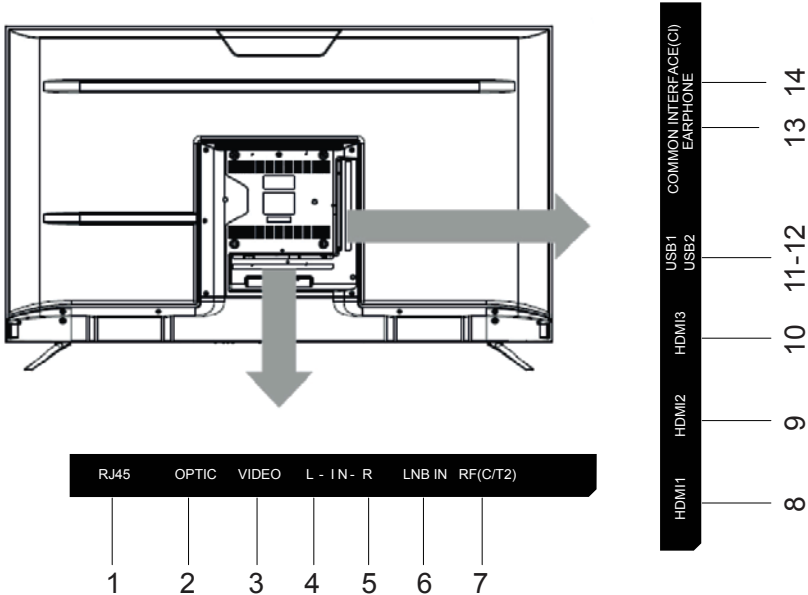

NO	INPUT / OUTPUT	NO	INPUT / OUTPUT
1	RJ45	8	HDMI Input 1
2	Optic Digital Audio Output	9	HDMI Input 2
3	Video Input	10	HDMI Input 3
4	Audio Input (L)	11	USB 1
5	Audio Input (R)	12	USB 2
6	LNB Input	13	Headphone Input
7	RF,C/T2 Antenna Input	14	CI Module Input

# 32WS1100 / 40WS1102 / 43WS1102 / SMART LED TV

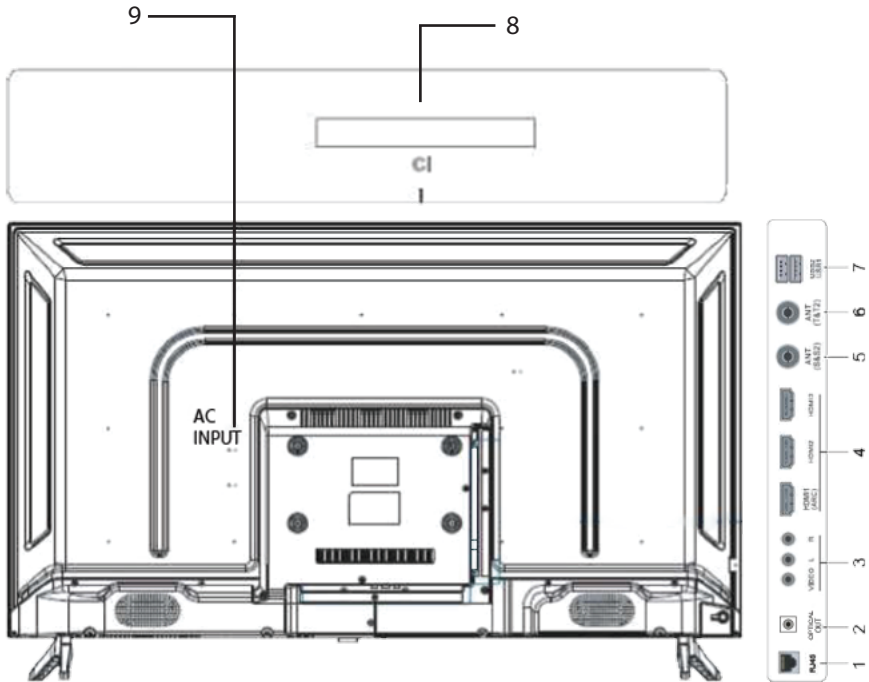

NO	INPUT/OUTPUT NAME
1	Ethernet Port (RJ45)
2	Digital Audio Output
3	AV Video and Audio Input
4	HDMI Inputs
5	Satellite Receiver Antenna Input (LNB)
6	Terrestrial Antenna Input
7	USB Inputs
8	CI Module Input
9	Power Supply Cable (110-220V AC 50/60 Hz)

# 50WS2104 / 55WS2104 / 65WS2104 UHD SMART LED TV

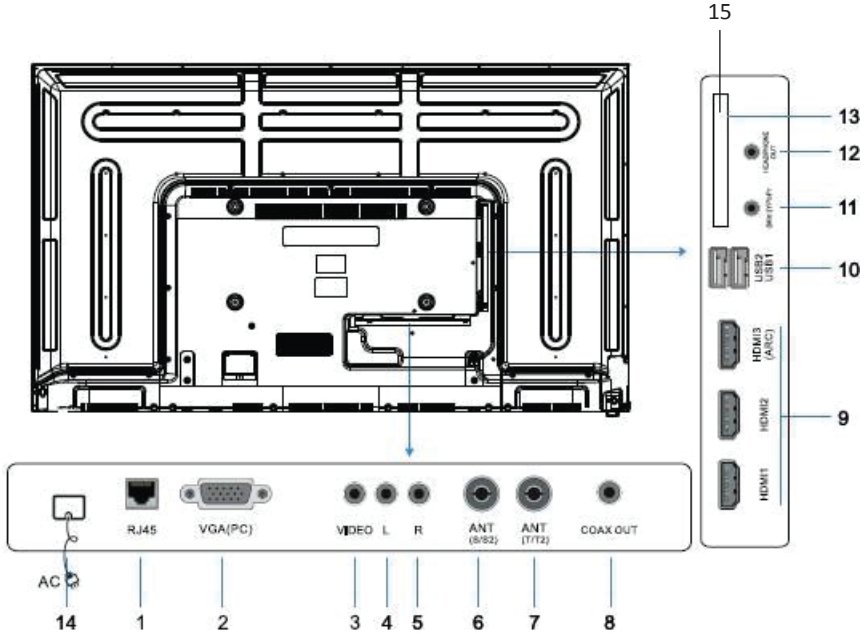

NO	INPUT/OUTPUT NAME	NO	INPUT/OUTPUT NAME
1	RJ45 Ethernet Connection	8	Coaxial Digital Audio Output
2	VGA Computer Input	9	HDMI Inputs
3	AV Video Input	10	USB Ports
4	AV Left Audio Input	11	Mini YPbPr Input
5	<b>AV Right Audio Input</b>	12	Headphone Output
6	Satellite Receiver Antenna Input (LNB)	13	Mini AV Video and Audio Input
7	Terrestrial Antenna Input	14	Power Supply Cable (110 - 220V)
15	Common Interface (CI)		

# 50WS1104 / 55WS1104 / 65WS1104 UHD SMART LED TV

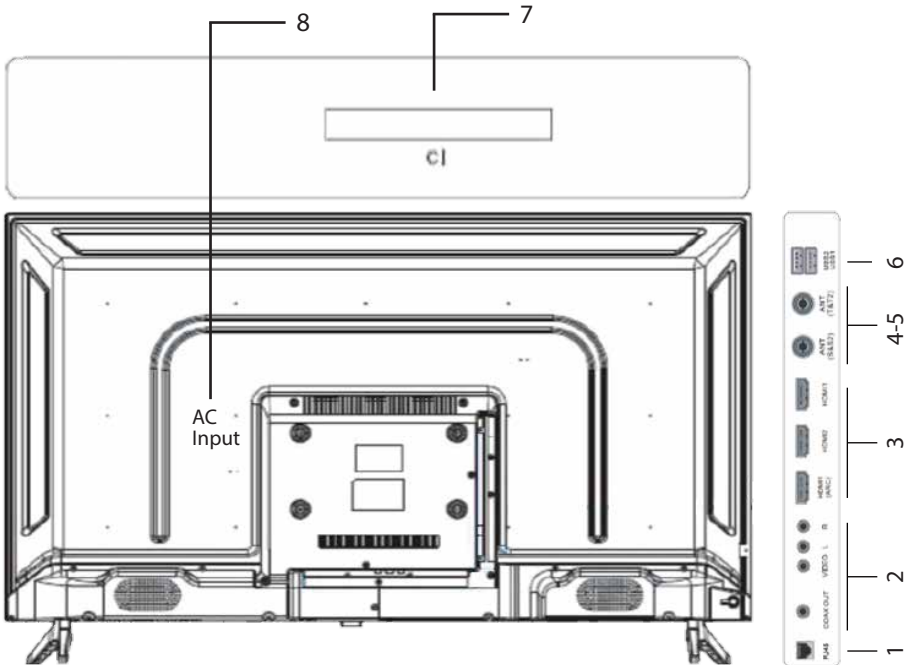

NO	INPUT/OUTPUT NAME
1	Ethernet Port (RJ45)
2	AV Video and Audio Input
3	HDMI Inputs
4	Satellite Receiver Antenna Input (LNB)
5	Terrestrial Antenna Input
6	USB Ports
7	CI Module Input
8	Power Supply Cable (110-220V AC 50/60 Hz)

## Input Source Selection

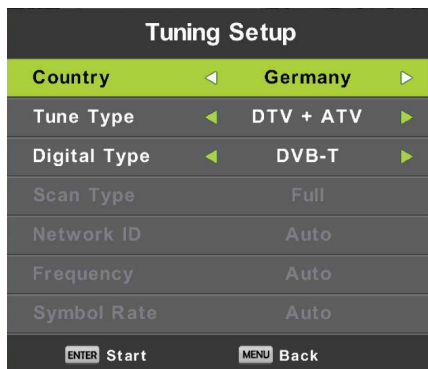

Press the SOURCE Button to open the Input Source menu above. Select the desired input source with the up and down buttons of the remote control and press the OK button.

## TV Functions

### MENU

To enter the menu, press the menu button on the remote control. Using the right/left arrow keys, select the menu you want to enter and press OK/ENTER button.

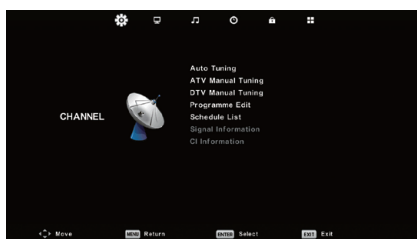

### CHANNEL

#### Auto Search (Satellite Antenna Source)

Select the Auto Search menu and press OK. Select the satellite from the menu that appears by using the right/left buttons on the remote control.

#### Scan Mode

Select one of the options Network, Default, Blind Scan and press OK.

**Channel Type:** You can select Open (unencrypted) + encrypted, Open or encrypted

**Service Type:** You can select one of the options All, DTV, Radio



**DiseqC 1.0:** If you use more than one satellite. Select according to the DiseqC connection. EXAMPLE: DiseqC1.0 LNB1: Turksat; LNB 2: Hotbird etc. You can select 1-4 SATELLITE.

**DiseqC1.1:** If you use this system in your signal, you can sort the satellites from 1 to 16 as described above

**Program Table:** Move, skip, and delete selections can be used to organize channels according to your wishes.

**Schedule List:** With this menu, the user can save the desired channels. For recording, USB must be plugged into the TV.

**NOTE:** Since not every broadcasting channel has time information, your records may not be correct. That is why you should select channels with time information.

**Signal Information:** Shows the signal information of the channel you are watching.

**CI Information:** Module (CAM) can be used to decrypt encrypted Channels. You can see the module information from this menu.

**Satellite Dish Antenna Setup:** You can use this menu to setup the satellite antenna connected to your TV.

Press the EPG button to view the Transponder list for the selected satellite. By selecting one or more frequencies, you can search the selected frequen

A new satellite can be added using the yellow button on the remote control.

Use the EPG button on the remote control to navigate to the frequency list.

You can edit, add, delete and scan frequencies using the colored buttons on the remote control.

## PICTURE

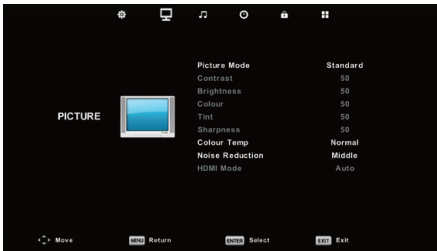

**Picture Mode:** By selecting one of the options Dynamic, Standard, or Soft, you can watch with predefined settings. By selecting the User mode, you can adjust the contrast, brightness, color, sharpness, color temperature, and noise reduction as you wish.

## SOUND

**Sound Mode:** By selecting one of the options Standard, Music, Cinema, or Sports, you can watch with predefined settings. When Personal mode is selected, you can adjust the treble and bass settings as desired.

**Balance:** you can adjust the sound distribution between the left and right speakers.

**AVL:** When set to On, prevents a sudden increase in volume when moving between channels.

**SPDIF Mode:** By using this menu you can set the digital audio output mode.

## TIME

**Clock:** Displays the current time setting.

**Time Zone:** The region must be chosen properly in order for the clock to work correctly. For Turkey it should be set to +3.

**Switch-off time:** You must select one of these times for the TV to turn off automatically at 15, 30, 45, 60, or 90 minutes.

**Auto Power Off:** Your TV may turn off automatically if it does not receive commands from the remote control or keypad for a certain period of time. To activate this feature, you must select one of the 3, 4, or 5 hour options.

**OSD Duration:** From this menu you can set the disappearance time of the menus used on the TV screen.

## LOCK

**Lock system:** To activate the system lock, enter 0000 in this menu to activate a submenu. Turn the closed system lock to the open position.

**Set Password:** In this menu, set the password you will use.

**Program Lock:** From this menu you can lock the channel you wish. Select the channel to be locked and press the green button on the remote control.

**Parental Control:** You can put a lock for ages between 3 and 18.

**NOTE:** Make a note of the password you have set and do not forget it.

## SETUP

**OSD Language:** The menu language of the TV can be selected.

**TT Language:** The Teletext language of the TV can be set from this menu.

**Audio Languages:** The audio language can be selected from this menu if the broadcasting channel also supports second or more languages.

**Subtitle Language:** If the broadcast channel supports subtitles, you can select the subtitle language you want to watch the broadcast in here.

**Hearing Impaired:** You can toggle hearing impaired support on and off if the broadcasting channel has this feature.

**PVR File System:** If you have a USB or HDD plugged in, you can see the file system.

**Screen Format:** You can adjust the aspect ratio of the image from this menu. You must select 16/9 to view in full screen.

**Blue Screen:** If this mode is on, the TV screen will automatically turn blue if there is no broadcast. It remains black in the off position.

**Initial Setup:** You can re-setup your TV by going to the initial setup menu and selecting the OSD language, the country selection, and the satellite / terrestrial / cable broadcast selection.

**Reset:** From this menu you can restore the original settings.

## USE WITH TERRESTRIAL ANTENNA

**DTV Search:** Select Auto search and press OK. From the drop-down menu, select the

Tuner type. Select ATV+DTV OR ATV, DTV ONLY and press OK. Select DVB-C from this menu and press OK if you want to search for cable TV broadcasts.

Select these menus, enter the required values, and press OK to make manual tuning for ATV manual search or Cad manual tuning.

Select Photo, Music, Movie, Movie, Text from the menu that appears, depending on what information you have stored on the USB. Press the OK button if there is more than 1, select the ones you want to start, and press the OK button, and it will start.

## MEDIA PLAYER FUNCTIONS

Insert the USB flash drive into the TV and press the source button. Using the up/down directional T-keys, select the Media option. Select the media type you want to play with the right/left arrow keys, and then select the file you want to play from the drop-down menu.

## TECHNICAL SPECIFICATIONS

<b>32WS2000</b>	
Viewing Angle	178° (Horizontal) / 178° (Vertical)
Input / Output	Input: 1xTerrestrial Antenna, 1xLNB Input (Satellite Dish Antenna), 2xHDMI, 1x Mini AV, 1x Mini YPbPr, 1xVGA, 1xPC Audio Input, 1x USB Output, 1x CI Module input Output: Headphones, Digital Audio Output
Speaker Output	2x8W
Operating Voltage	AC 100-240V 50/60Hz
Power Consumption	60W
Accessories	User Manual, Remote Control, 2x AAA Batteries

	<b>24WS1000</b>	<b>32WS1000 / 32WS1001</b>
Viewing Angle	178° (Horizontal) / 178° (Vertical)	
Input / Output	Built-in satellite receiver (DVB-S/S2), Suitable for terrestrial and cable broadcasting (DVB-T/T2,DVB-C), 1x Terrestrial antenna input, 3xHDMI, 2xUSB, 1xAV, 1xCL Module input, Digital Audio Output	Built-in satellite receiver (DVB-S/S2), Suitable for terrestrial and cable broadcasting (DVB-T/T2,DVB-C), 1x Terrestrial antenna input, 3xHDMI, 2xUSB, 1xAV, 1xCL Module input, 1xLNB, Digital Audio Output
Speaker Output	2x3W	2x8W
Operating Voltage	AC 100-240V 50/60Hz	
Power Consumption	36W	56W
Accessories	User Manual, Remote Control, 2x AAA Batteries	

**32WS2100 / 40WS2102 / 42WS2102 / 43WS2103 / 50WS2104  
55WS2104 / 65WS2104 / 32WS1100 / 40WS1102 / 43WS1102  
SMART LED TV**

## Setup

The setup wizard will appear when you start your device for the first time. You can complete the setup by following the on-screen guidance messages. To start the Setup, press OK/ENTER.

Use the Up / Down arrow keys to select the language and press OK/ENTER.

Use the Up / Down buttons to select the time zone and press OK/ENTER.

To set up the wireless network, select a network from the list and enter your password. You can skip this step with the Right arrow key and do it later.

To select which source the device will display at startup, use the Up / Down arrow keys.

## TV Functions

### MENU

To enter the menu, press the menu button on the remote control. Using the right/left arrow keys, select the menu you want to enter and press OK/ENTER button.

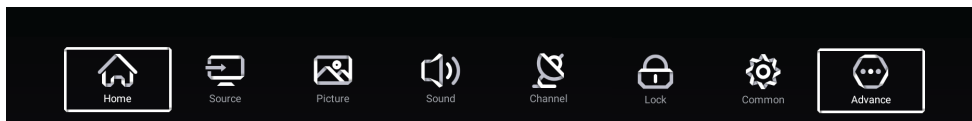

## INPUT FUNCTION SELECTION

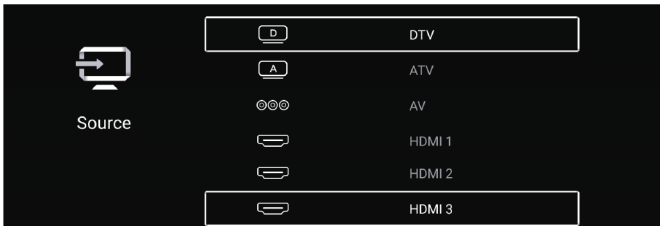

By pressing the SOURCE button on the remote control and selecting with the Up/Down buttons, you can access the source menu. Press OK/ENTER to display the source you have selected.

**TV:** Select this option to watch Satellite, Analog TV, and Digital Terrestrial TV broadcasts.

**AV Video Input:** You can watch by connecting the AV output of your external device to your TV with a triple AV cable (Video+ Right/Left Audio). (An AV Cable is not supplied with the device.)

**HDMI1, HDMI2, and HDMI3 Inputs:** Select the relevant option to access the device or devices you have connected to HDMI. (A HDMI cable is not supplied with the device.)

To enter the menu, press the menu button on the remote control. Using the right/left arrow keys, select the menu you want to enter and press OK/ENTER button.

### PICTURE

**Note:** Contrast, brightness, color, and sharpness settings can be made when the picture mode is selected as "User."

**Standard:** Default mode to enable users to obtain high-quality images under normal light.

**Movie:** Default mode to ensure users get high-quality images when watching movies.

**Vivid:** The mode supposed to make the image colors appear more beautiful and vivid.

**Energy Saving:** Default mode to save energy by reducing screen brightness.

**User:** User-defined image settings

**Contrast:** Contrast adjustment

**Brightness:** Brightness adjustment

**Color:** Color intensity adjustment

**Sharpness:** Sharpness adjustment of the image

**Change Aspect Ratio:** You can change the aspect ratio to Auto / 16:9 / 4:3 / Zoom1 / Zoom2 in this section or by pressing the ASPECT button on the remote control. The aspect ratio will change each time you press the button. Note: May not apply to all input sources.

**Color Temperature:** With this option, you can set the overall color of the image to Cool, Normal, or Warm.

**Cool:** Default mode for a soft blue color image.

**Normal:** Default mode for a live image.

**Hot:** Default mode for a red color image.

**DLC:** Dynamic light control. Dark, Normal, Bright or Off can be selected.

## SOUND

**Standard:** Default mode for balanced sound in all environments.

**Music:** Default mode for keeping the original sound. Can be used for music programs.

**Movie:** Default mode for rich sound by boosting treble and bass.

**News:** mode used to emphasize speech sounds.

**User:** Default mode for customizing music settings.

**Bass:** Adjust the bass.

**Treble:** Adjust the treble.

**Note:** Bass and Treble settings are available when the audio mode is selected as "User".

**Balance:** Adjust the left and right channel output balance.

**AVC:** Automatic volume control.

**Audio Description:** Can be selected as on or off.

**Hearing Impaired:** Can be selected as on or off.

**Note:** Audio Description and Hearing Impaired options are only available if the TV broadcast supports them.

### **Other Settings**

**Digital Audio Output:** You can select the digital audio output as Off / RAW / PCM.

**Digital Audio Output Delay:** For image and sound synchronization, you can change the delay value of the audio.

**Surround:** Environment sound effect You can select as On or Off.

**Audio Only:** Only audio is heard without the screen being displayed. You can choose between On or Off.

### **CHANNEL MENU**

From this menu, you can adjust your TV's broadcast selection (DVB-T/T2, DVB-S/S2 or DVB-C), satellite dish, and channel settings.

**Antenna Type:** To set, choose one of the options Aerial / Cable / Satellite.

Here, it is referred to as "aerial," i.e. terrestrial broadcasting (DVB-T/T2), "cable," i.e. cable TV broadcasting (DVB-C), and "satellite," i.e. satellite broadcasting (DVB-S/S2).

**Scan:** Here you can search for channels automatically or manually.

Analog scanning is used to scan cable or terrestrial TV channels broadcast as analog and digital scanning is used to scan cable or terrestrial TV channels broadcast as digital.

Make sure that the antenna cable for the type of broadcast you will be using is connected to the appropriate antenna input on your TV before you start scanning.

### **Satellite Antenna Tuning and Channel Scanning**

To watch satellite broadcasts, first select the antenna type as "SATELLITE."

**Select a Satellite Scan Mode:** Select one of the options Network / Blind Scan.

**Channel Type:** Specify the channel search type by selecting one of the options Unencrypted / Encrypted / All.

**Service Type:** Select one of the options Radio / TV / All.

**Add LNB:** From the menu that opens, select the satellite you want to scan and press OK/ENTER. Use the right arrow key to switch to the right-side window and set DiseqC1.0. Return to the previous menu with the EXIT button.



**Start Automatic Tuning for All LNBS:** The auto search will start for the satellites you selected, and the channels will be saved automatically after it is finished.

**CI Card:** With this menu you can view and change the Common Interface module settings.

**Audio Language:** If the satellite broadcast supports more than one audio language, you can select the audio language from this menu.

## **Channel List**

You can edit the channel list and favorite channel settings from this menu. To edit the channel list, scroll to the DTV channel list and select the desired channel with the directional buttons. Press the Menu button to move the channel, move it to the top, delete it, add it to your favorites list, or skip it from the submenu that appears.

**EPG:** You can view the broadcast schedule of the channels on satellite broadcasts that support it.

## **LOCK**

You can change the current password (1234), enable password entry for system settings, set the age restriction if the broadcast you're watching sends age restriction information, and lock the buttons on the TV in this section.

**Change Password:** From this section you can change the current password.

**System Lock:** When this option is enabled, the TV settings will be password protected.

**Parental Control:** Setting the age restriction for the broadcast being watched. This feature must be supported by the broadcast. Otherwise, the settings will be invalid.

## **GENERAL SETTINGS**

**PVR Setting:** Disk settings can be made from this section if a USB disk is connected to record TV broadcasts.

**OSD Timer:** You can set the duration of the OSD menu on the screen with this menu.

**Auto Standby Timer:** Wait time for automatic switch-off when no button is pressed from the remote control or TV. Off can be set to 1 3 hours 1 4 hours or 5 hours. After

the set time, the TV turns off automatically.

**Sleep Timer:** Auto power off timer. Off can be set to / 15 min./ 30 min./ 45 min. / 60 min. / 90 min. / 120 min. or 240 min. After the set time, the TV turns off automatically.

**Blue Screen:** The screen color to be used when there is no broadcast can be selected as "On" or "Off."

Audio language 1. / Audio language 2. / Subtitle language 1. / Subtitle Language 2:  
Preferred audio language and subtitle settings for supported TV shows.

**HDMI CEC:** When you connect a display device with HDMI CEC support to your TV, you can enable this feature, and the TV will turn off and on automatically when you use the display device's own remote control.

Menu Reset: Resets all menu settings.

# HOMEPAGE

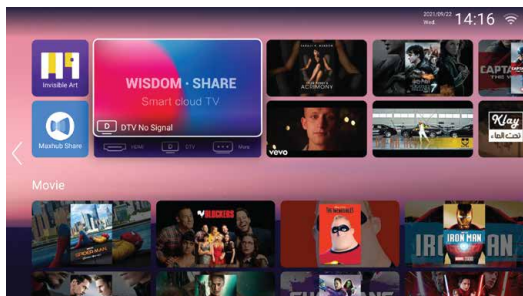

On the Home page you can see the apps installed on your TV, icons for switching to the media player and other input sources.

**Note:** The home page view may differ depending on the software version.

## APPLICATIONS

In this section, you can view the apps that are currently installed on your TV as well as download and install new apps from the store.

# MEDIA PLAYER FUNCTIONS

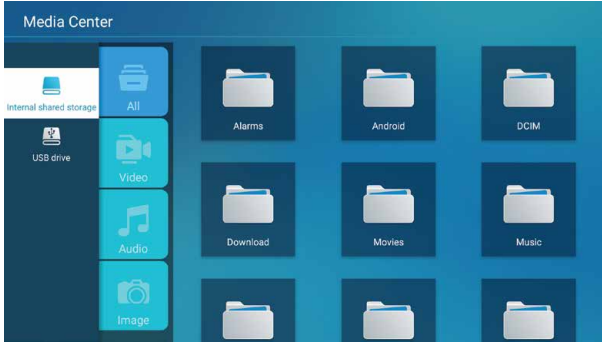

## Video

Use the up and down arrow keys to select the "Video" icon. Press the ENTER button to confirm, and then navigate right to the folder by pressing the ENTER button to open the corresponding folder. After selecting the file, press ENTER to open it. You can operate with the left and right buttons.

## Sound

Select the "Audio" icon with the up and down arrow keys, press ENTER to confirm, and then press right towards the folder, pressing ENTER to open the appropriate folder. After selecting the audio file, press ENTER to open it. You can operate with the left and right buttons.

## Picture

Select the "Picture" icon with the up and down arrow keys, press ENTER to confirm, and then press right towards the folder, pressing ENTER to open the appropriate folder. After selecting the image, press ENTER to open it, and then use the left and right keys to operate.

## SETTINGS

Select the Settings icon and press ENTER.

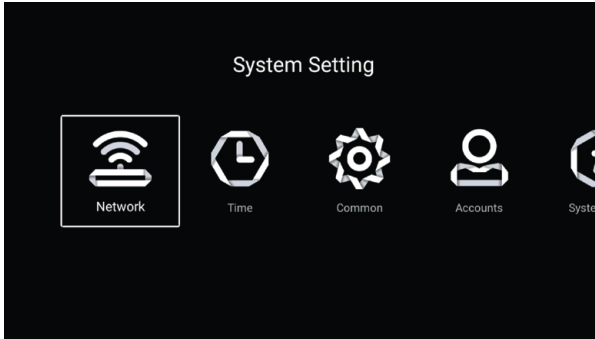

**General:** To view the Android operating system settings on your device, select this heading and press OK/ENTER.

**Accounts:** From this menu, you can view, add or remove user accounts for applications running on your device's Android operating system.

**Network:** To connect your device to a wireless network, select Network and press ENTER. From the "Network Mode" menu, select the Network Type to which you will connect your device. If you select cable as the network type, select the "Wireless" option at the bottom and press OK/ENTER. Then select the name of the network you want to connect to and press ENTER. Enter your password in the menu that opens, and then press Connect.

**Time:** From this menu, you can manage the device's Android operating system time settings.

**System Information:** From this menu, you can view the features of your device.

## TECHNICAL SPECIFICATIONS

MODEL NO	32WS2100	40WS2102	42WS2102
VOLTAGE	AC 100-240V 50/60Hz		
POWER	60W	74W	74W
SCREEN SIZE	32"	40"	42"
RESOLUTION	1366x768	1920x1080	1920x1080
SOUND OUTPUT	2x8W		
INPUT	1x Terrestrial Antenna, 1x LNB (Satellite Antenna), 1xRJ45 Ethernet, 3xHDMI, 1xAV, 1xCI Module, 2xUSB		
OUTPUT	1xHeadphone Output, 1xCoaxial Audio Output		

MODEL NO	43WS2103
VOLTAGE	AC 100-240V 50/60Hz
POWER	74W
SCREEN SIZE	43"
RESOLUTION	1920x1080
SOUND OUTPUT	2x8W
INPUT	1x RJ45 Ethernet, 3x HDMI, 2x USB, 1x Anten, 1x AV, 1x CI
OUTPUT	1xHeadphone Output, 1xDigital Audio Output

MODEL NO	50WS2104	55WS2104	65WS2104
VOLTAGE	AC 100-240V 50/60Hz		
POWER	120W	140W	160W
SCREEN SIZE	50"	55"	65"
RESOLUTION	3840x2160	3840x2160	3840x2160
SOUND OUTPUT	2x8W		
INPUT	1x Terrestrial Antenna, 1x LNB (Satellite Antenna), 1x RJ45 Ethernet, 3x HDMI, 1x AV, 1x CI Module, 2x USB, 1x YPBr, 1x VGA		
OUTPUT	1x Headphone Output, 1x Coaxial Audio Output		

MODEL NO	32WS1100	40WS1102	43WS1102
VOLTAGE	AC 100-240V 50/60Hz		
POWER	56W	90W	90W
SCREEN SIZE	32"	40"	43"
RESOLUTION	1366 x 768	1920x 1080	1920x1080
SOUND OUTPUT	2x8W		
INPUT	1x Terrestrial Antenna, 1x LNB (Satellite Antenna), 1xRJ45 Ethernet, 3xHDMI, 1xAV, 1xCI Module, 2xUSB		
OUTPUT	1xCoaxial Audio Output		

# 50WS1104 / 55WS1104 / 65WS1104

## SMART LED TV SETUP

### Setup

The setup wizard will appear when you start your device for the first time. You can complete the setup by following the on-screen guidance messages. To start the Setup, press OK/ENTER.

1. Use the Up / Down arrow keys to select the language and press OK/ENTER.
2. Use the Up / Down buttons to select the time zone and press OK/ENTER.
3. To set up the wireless network, select a network from the list and enter your password. You can skip this step with the Right arrow key and do it later.
4. To select which source the device will display at startup, use the Up / Down arrow keys.

### TV Functions

#### MENU

To enter the menu, press the menu button on the remote control. Using the right/left arrow keys, select the menu you want to enter and press OK/ENTER button.

#### SELECTION OF INPUT SOURCES



Press the SOURCE button on the remote control to select one of the Analog, DVB (Digital Terrestrial), DVB C (Cable), DVB S (Satellite), AV, HDMI1, HDMI2, and HDMI3 inputs,

and use the right/left arrow keys to select the source you want to watch, then press OK.

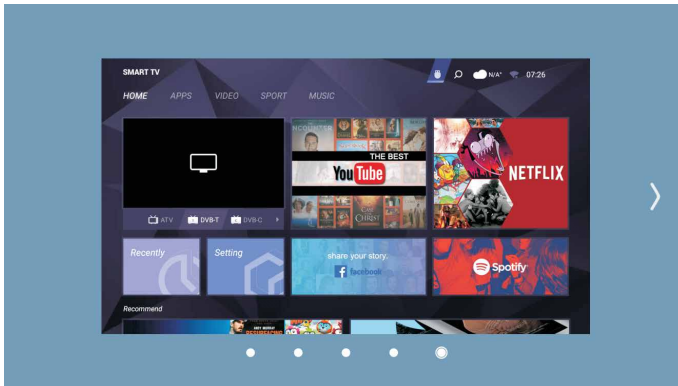

While on the Smart TV home page, use the up/down arrow keys to scroll to the input sources under the **preview window**, and use the right/left arrow keys to scroll to the source you want to watch.

**Analog:** Select this option to watch analog TV broadcasts.

**DVB-T (Terrestrial):** Select this option to watch digital terrestrial TV broadcasts.

**DVB-C (Cable):** Select this option to watch cable TV broadcasts.

**DVB-S (Cable):** Select this option to watch satellite TV broadcasts.

**AV Video Input:** You can watch by connecting the AV output of your external device to your TV with a triple AV cable (Video+ Right/Left Audio). (An AV Cable is not supplied with the device.)

**HDMI1, HDMI2, and HDMI3 Inputs:** Select the relevant option to access the device or devices you have connected to HDMI. (A HDMI cable is not supplied with the device.)

To enter the menu, press the menu button on the remote control, then use the Right/Left direction buttons to select the menu you want to enter and press the ENTER button.



## PICTURE MENU

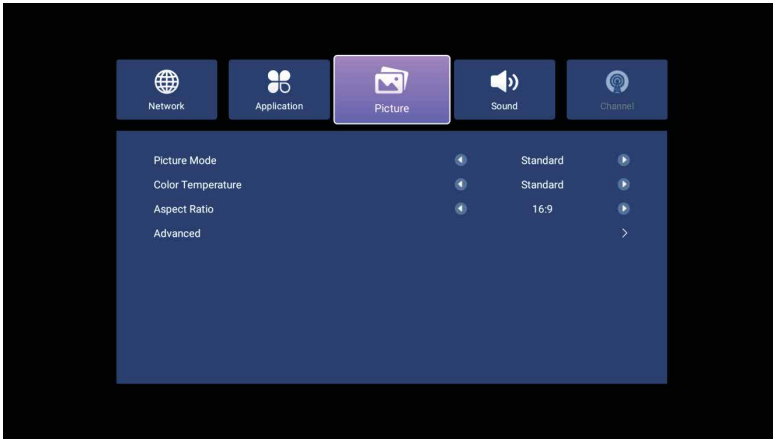

**Picture Mode:** From this menu you can adjust the backlight, brightness, contrast, color saturation and sharpness settings. You can select a preset option by selecting Standard, Dynamic, Movie, Energy Saver. You can change the settings to suit your taste by selecting the User option and pressing Enter.

**Color Temperature:** You can choose from Standard, Warm, or Cool.

**Aspect Ratio:** From this menu, you can change the aspect ratio of the image on the screen. The aspect ratio of digital broadcasts is 16:9, which is suitable for widescreen formats.

**Extended:** You can use this menu to perform the following operations.

**Noise Reduction:** You can adjust the level of noise reduction to reduce unwanted effects in digital broadcasts.

**DLC (Dynamic Light Control):** If you want the backlight to automatically adjust according to the image on the screen, you can turn this feature on with the Enter button.

**HDR (High Dynamic Range):** This feature increases contrast by making the bright parts of the image appear brighter and the dark parts appear darker. You can toggle this feature on and off with the Enter button.

**NOTE:** HDR is only available for supported broadcasts.

## SOUND MENU

**Picture Mode:** You can adjust the bass and treble settings in this menu. You can select a preset option by choosing from Standard, User, Sport, Movie, Music. You can change the settings to suit your taste by selecting the User option and pressing Enter.

**Surround:** You can activate the surround sound effect from this menu. You can toggle this feature on and off with the Enter button.

**AVC (Automatic Volume Control):** You can use this feature to compensate for the difference in volume between channels during channel switching. You can toggle this feature on and off with the Enter button.

**Extended:** You can use this menu to perform the following operations.

**Balance:** Using the Right / Left arrow keys, you can adjust the sound balance between the right and left speakers.

**Digital Output:** You can select the desired setting for the type of device you connect to the digital audio output.

## CHANNEL MENU

### (Satellite Broadcast Mode)

From this menu you can adjust the satellite dish and channel settings of your TV.

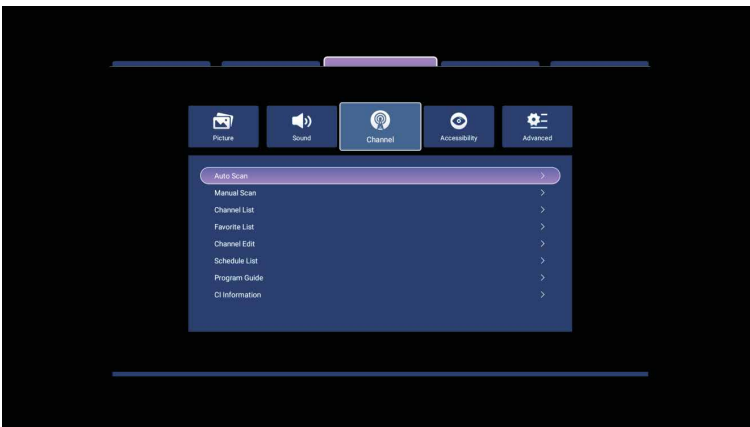

**LNB Selection:** You can change the type of LNB you are using from this menu. Select the Universal LNB option for Turksat and Hotbird satellites.

**Auto Scan:** You can change the satellite you want to search from the list by entering the Satellite Selection option with the up/down arrow keys. You can narrow down your search by selecting Free or Encrypted from the Channel Type drop-down menu.

You can select DTV/Radio/All as the search type in the Program Type option. In Scan mode, you can scan previously registered TPs using the default option, or you can select Full Scan/Network. After you've chosen these options, you can begin the search by pressing the "Enter" button on the remote control and then the "Search" button with the down arrow key.

**Manual Scan:** You can change the satellite you want to search from the list by entering the Satellite Selection option with the up/down arrow keys. By pressing the "Enter" button on your remote control while on the Transponder option, you can type the frequency (TP) you want to search for. You can then start the search by pressing the "Enter" button on the remote control.

**Satellite Dish Setup:** Select the satellite you want to watch from the list on the right side of the screen with the up/down arrow keys and press "Enter". Press the right direction button to edit the satellite parameters. Select the parameter to be edited by

using the up/down arrow keys.

**LNB Setting:** You can change the LNB type with the right/left direction buttons. The commonly used LNB type in Turkey is 9750/10600.

**LNB Power:** Shows the status of the LNB power. The default value is "On."

**22KHz:** Indicates the status of the 22KHz signal. The default value is "Automatic."

**Tone Burst:** You can use this menu to set the Tone Burst signal. The default value is "Disabled."

**DiseqC 1.0:** If you are using more than one satellite dish at the same time, you can determine which satellite is connected to which LNB with the right/left direction keys.

**DiseqC 1.1:** If you are using more than one satellite dish at the same time, you can determine which satellite is connected to which LNB with the right/left direction keys.

**DiseqC 1.2 and DiseqC 1.3:** If you are using a motorized satellite dish, you can adjust the position setting from this menu.

**Channel List:** You can view the registered channels from this menu.

**Favorites List:** You can view the channels in the favorites list from this menu.

**Edit Channel:** Select the channel you want to edit with the up/down arrow keys and press ENTER. Select the operation you want to perform and press "Enter". For example, after selecting channel move, use the Up/Down arrow keys to move the channel to the desired position and press ENTER.

**Program Guide:** You can view the EPG information for supported broadcasts from this menu.

**CI Information:** If you have installed a module on your TV to watch encrypted channels, you can view information about the encryption system from this menu. If the module is not installed, this option will not be active.

### **(Analog Broadcast Mode)**

If your TV source selection is Analog (ATV), you can change the channel settings with this menu.

**Auto Scan:** When you select this option and press the "Enter" button, an automatic channel search will start and the found channels will be automatically memorized.

**Manual Scan:** You can change the frequency while on the Current Frequency option by pressing the Right/Left buttons, and you can repeat this process until you reach the desired frequency. While in the Program Search mode, you can use the Right/Left arrow keys to perform an automatic scan in the direction of your choice.

### **(Digital Terrestrial Broadcasting - DVB-T Mode)**

If your TV source selection is (DVB-T), you can change the channel settings with this menu.

**Auto Scan:** When you choose this option and press "Enter" to open the LCN option, the channel numbers are locked and cannot be changed.

To start the auto scan, select Start Scan and press ENTER.

**Manual Scan:** When you select this option and press the "Enter" key, you can use the right/left arrow keys to change the frequency channel you want to scan by selecting the Channel ID from the menu that appears. After choosing the frequency, select the Start scan option and press ENTER.

**Channel List:** You can view the registered channels from this menu.

**Favorites List:** You can view the channels in the favorites list from this menu.

**Edit Channel:** Select the channel you want to edit with the up/down arrow keys and press ENTER. Select the operation you want to perform and press "Enter". For example, after selecting channel move, use the Up/Down arrow keys to move the channel to the desired position and press ENTER.

**Program Guide:** You can view the EPG information for supported broadcasts from this menu.

**CI Information:** If you have installed a module on your TV to watch encrypted channels, you can view information about the encryption system from this menu. If the module is not installed, this option will not be active.

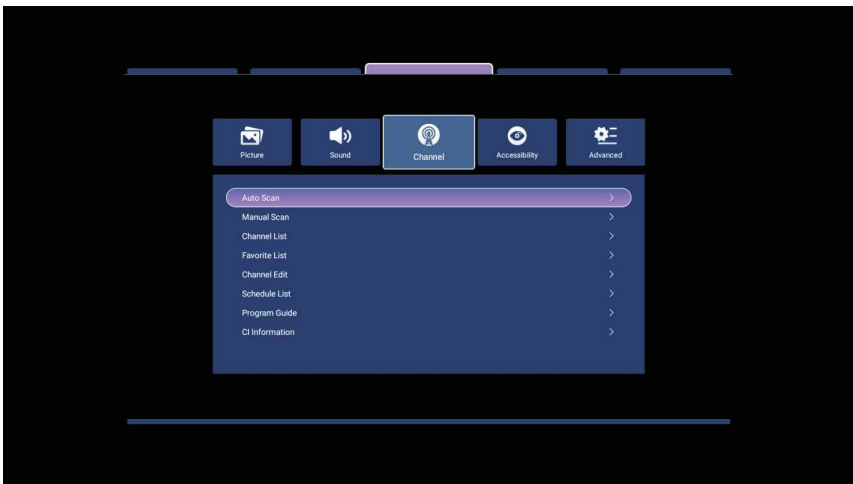

## **(Cable Broadcast DVB-C Mode)**

If the source selection on your TV is Cable (DVB-C), you can adjust the channel settings with this menu.

**Auto Scan:** When you choose this option and press "Enter" to open the LCN option, the channel numbers are locked and cannot be changed. When the Scan Mode is set to "Full Scan," the entire frequency band is scanned and the channels found are saved. If "Network Scan" is selected as Scan Mode, you must enter the network scan parameters provided by your operator. After selecting the scan mode, select Start scan and press ENTER.

**Manual Scan:** When you select this option and press the "Enter" button, you can use the right/left arrow keys to change the frequency channel you want to scan by selecting the frequency from the menu that appears. After choosing the frequency, select the Start scan option and press ENTER.

**Channel List:** You can view the registered channels from this menu.

**Favorites List:** You can view the channels in the favorites list from this menu.

**Edit Channel:** Select the channel you want to edit with the up/down arrow keys and press ENTER. Select the operation you want to perform and press "Enter". For example, after selecting channel move, use the Up/Down arrow keys to move the channel to the desired position and press ENTER.

**Program Guide:** You can view the EPG information for supported broadcasts from this menu.

**CI Information:** If you have installed a module on your TV to watch encrypted channels, you can view information about the encryption system from this menu. If the module is not installed, this option will not be active.

## **ACCESSIBILITY MENU**

The features in this menu are only available for supported broadcasts. These menus can display audio description provided by the broadcaster as well as subtitles for the hearing impaired.

# ADVANCED MENU

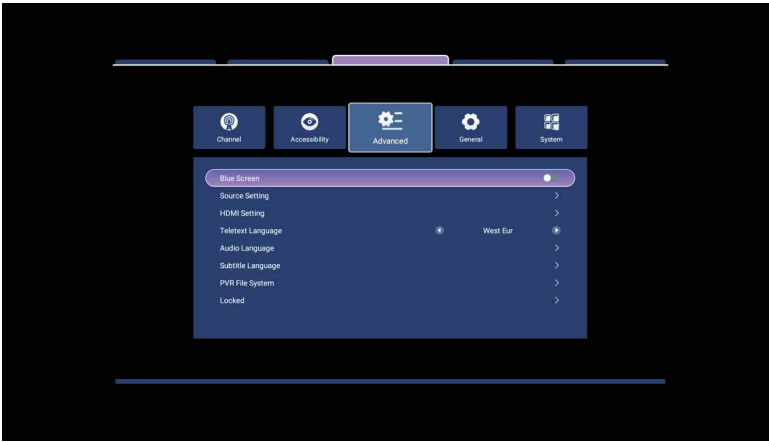

**Blue Screen:** When turned on, the screen will display blue when there is no signal on the screen.

**Source Setup:** You can use this menu to hide or show input sources in the Source menu. By pressing ENTER on the desired source, you can also change the name.

**HDMI Setup:** Use this menu to control your TV using the remote control of any HDMI CEC enabled external device.

**Teletext Language:** From this menu, you can select the language required for the



correct display of the character set in teletext broadcasts.

**Audio Language Settings:** It is used to select the audio language for broadcast support.

**Subtitle Settings:** It is used to select the subtitle language for supporting broadcasts.

**PVR File System:** From this menu, you can configure the external disk that will be used to record to a USB disk.

**Record to Disk:** If your device has multiple USB drives, you can select which one to record to from this menu.

**Time Shift Size:** You can specify the file size allowed for the Time Shift function from this menu.

**Start Time Shift:** You can start the Time Shift function from this menu or by pressing the T. SHIFT button on the remote control.

**Saved List:** You can use this menu to view and play programs saved on a USB flash drive.

## LOCK MENU

Using this menu we can restrict user settings on the TV menu. You can toggle the **System Lock** option on/off with the right/left arrow keys. The default password to activate the lock is set to "0000." Using the **Channel Lock** option, you can lock the channels you specify and prevent them from being displayed.

You can set age group restrictions on supported broadcasts using the **Parental Control** option. You can create a new password from the menu that appears by pressing enter button and selecting the **Change Password** option.

# General settings

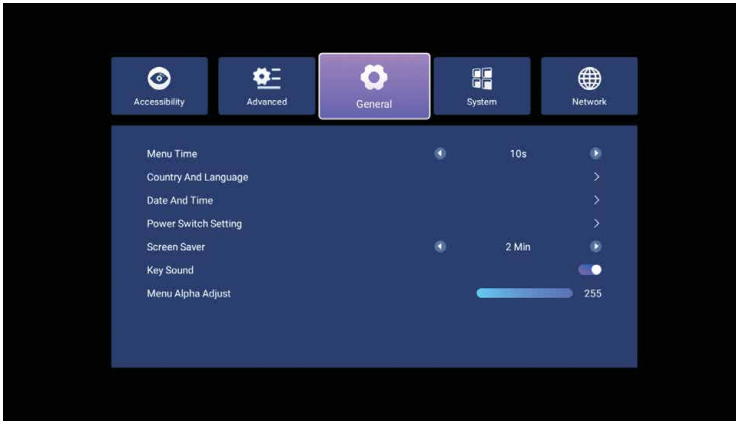

**Menu Duration:** The duration of the information screen stays on the screen.

**Country and Language:** From this menu, you can change the country and language settings you selected on the setup screen.

**Date and Time:** You can change the date and time settings from this menu.

**Start Time:** Select "Network" for the TV to receive the date and time settings from the Internet or "TV" for the TV to receive the date and time settings from the incoming TV broadcast. To set the date and time manually, select "Off" and change the settings below manually.

**Power Switch Settings:** This menu allows you to change your device's power-on settings.

**Power Desktop:** Select "TV" to start your device in TV mode, "Home" to start it in Smart TV mode, or "Memory" to start it in the last off mode.

**Screen Saver:** Set the standby time for your TV to display screensaver images when no commands are received from the remote control or no signal is received over the air.

**Keystroke Sound:** Set this feature to "On" if you want your device to beep when it receives a command from the remote.

**Alpha Menu Settings:** You can adjust the transparency of the OSD menu from this menu.

# SYSTEM MENU

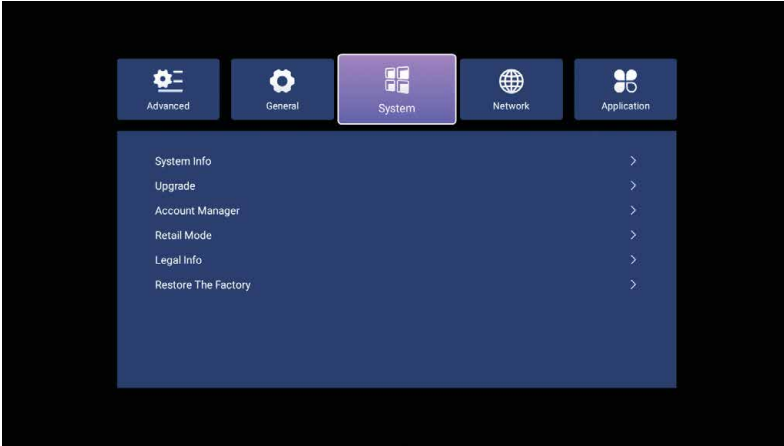

**System Information:** You can view the software and hardware information of your device from this menu. You can change the name of your device by pressing the ENTER button while on the "Device Name" option.

**Account Manager:** This menu allows you to manage the accounts you've set up for Smart TV applications.

**Factory Reset:** You can use this menu to reset your device to factory default settings. The default password is "0000".

## NETWORK MENU

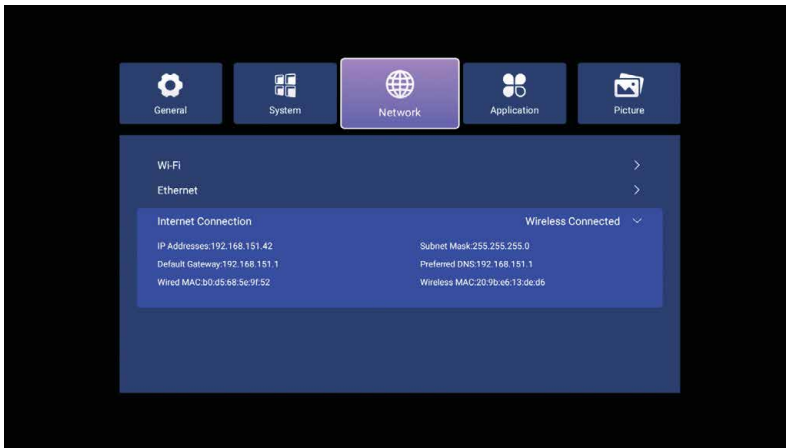

To connect your device to a wireless network, select Wifi and press ENTER. When the Wifi feature is enabled, you can view the wireless networks to which your device can connect. Then hover over the name of the network you want to connect to and press ENTER. Enter your password in the menu that opens, and then press Connect.

To connect your device to a wired network, connect an Ethernet cable with an internet connection to the RJ45 connector on the back. In the Ethernet menu, you can configure the Ethernet connection.

## APPLICATION MENU

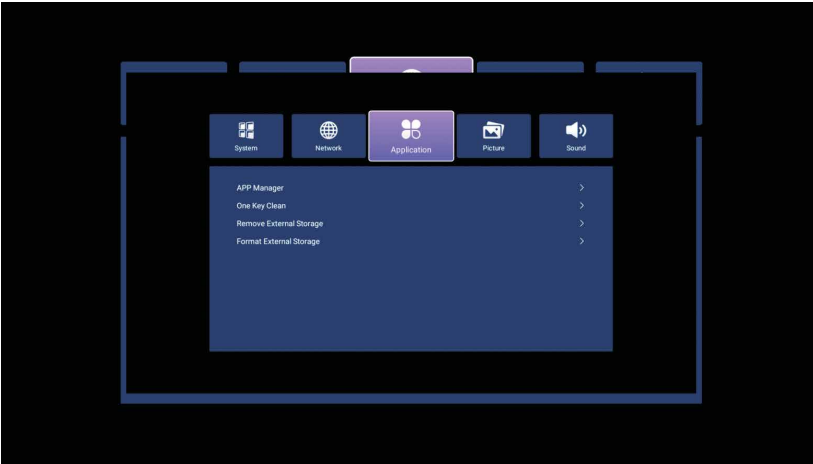

**Application Manager:** You can use this menu to manage the Smart TV apps installed on your device.

**Single Key Clean:** You can clear the cache data used by apps using this menu.

**Remove External Storage:** You can use this menu to safely remove the USB drive inserted into your device.

**Format External Storage:** You can use this menu to format the USB drive inserted into your device. If you format your drive, all the data on it will be deleted.

# Home page

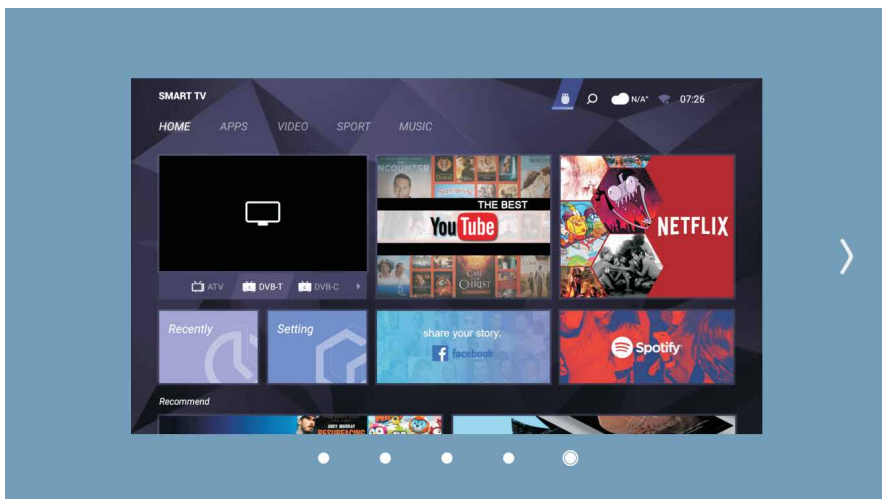

On the Home page, you can see the apps installed on your TV, icons for switching to the file manager, and other input sources. Use the arrow keys to point to the application icon you want to install and press ENTER. Then follow the on-screen instructions to finish installing the application.

# MEDIA PLAYER FUNCTIONS



To open the media player, click the USB drive icon at the top of the home page. You can view the files by first selecting the drive and then the folder from the window that appears. Press ENTER after selecting the image, audio, or video file to open it.

By pressing the down arrow key, you can bring up the media player control bar. You can control the files you are listening to or watching using the Right/Left direction buttons or the media player buttons on the remote control.

### Technical Specifications

<b>MODEL NO</b>	<b>50WS1104</b>	<b>55WS1104</b>	<b>65WS1104</b>
<b>VOLTAGE</b>	AC 110-240V 50/60Hz		
<b>POWER</b>	100W	110W	160W
<b>SCREEN SIZE</b>	50"	55"	65"
<b>SOUND OUTPUT</b>	2x10W		
<b>INPUT</b>	1xRJ45 Ethernet, 3xHDMI, 1xLNB, 1xAntenna, 1xAV, 1xCI Module, 2xUSB		
<b>OUTPUT</b>	1xDigital Audio Output		

### TROUBLESHOOTING

<b>Problem</b>	<b>Possible Cause</b>	<b>What to do</b>
Device Won't Turn On	Power connection may have been made incorrectly	Make sure your device's power cord is plugged into
	Remote Control is not working	Remote Make sure the batteries in your remote control are properly inserted.
No audio or video	Satellite dish antenna not properly tuned	Satellite dish antenna not properly
	No signal or weak signal	Check the cable connections, connection of LNB and other equipment and/or have the satellite dish adjusted
No Signal alert	Satellite dish antenna not properly tuned	Satellite dish antenna not properly
	LNB is damaged	LNB must be replaced



# INFORMATION

In the event that it is understood that the goods are defective, the consumer, in accordance with Article 11 of Law No. 6502 on Consumer Protection, may use one of the rights:

- a) Return from the contract,
- b) Requesting a discount from the sale price,
- c) Request free repair of the sold goods,
- d) Requesting the replacement of the sold product with a defect-free equivalent.

In disputes arising from the exercise of his/her warranty rights, the consumer may apply to the Consumer Arbitration Committee or the Consumer Court in the place where the consumer has his/her place of residence or where the consumer transaction is made. **Note:** All illustrations, menu images, menu and function descriptions used in this manual are for reference only. The manufacturer reserves the right to change the technical specifications, device appearance and functions, menu appearance and functions, remote control and button functions, input/output connections and locations of the device without prior notice due to software and hardware development.

This sign indicates that waste electrical and electronic equipment should be collected separately. The uncontrolled disposal of devices bearing this marking, along with other household waste, is dangerous because hazardous waste can contaminate water and food supplies, posing a threat to human health and the environment. Devices bearing this mark must be recycled in recycling facilities in order to protect human health and the environment and to promote the long-term reuse of material resources. If you have used devices or batteries with this mark that have reached the end of their economic life, please contact recycling organizations or municipalities for safe recycling and follow local procedures.

## MANUFACTURER / IMPORTER COMPANY

SKY INOVASYON VE TEKNOLOJİ A.Ş. :

Başakşehir Mah. Hürriyet Bulvarı

No: 119 Başakşehir/ İstanbul/ Türkiye

Phone: 444 23 30 (pbx)

info@skytech.com.tr / www.skytech.com.tr

THE AVERAGE LIFESPAN IS 10 (TEN) YEARS.

